

Installation Instructions for: Model 3007 Direct Drive System USB Audit Lock

- Für Anweisungen auf **Deutsch** besuchen Sie bitte die folgende Website:
- Pour obtenir les instructions en **français**, veuillez consulter le site ci-dessous: www.sargentgreenleaf.com/OPinstr.php

Step 1: Open the Box

Open the S&G USB Audit Lock and make sure that you have the following parts.

- Base • (2) 9V batteries • Keypad • Direct Drive lock
- Chrome Ring • Screws • Cable • Spindle Shaft

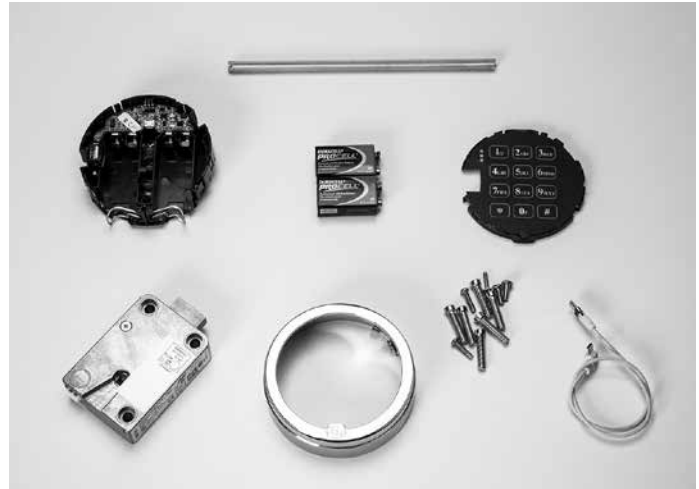

Step 2: Check Mounting Location

- This lock can be mounted to storage unit of any material as long as the lock is electrically grounded and the mounting surface is sufficiently sturdy.
- The mounting surface should be smooth and flat, with either ¼ - 20 or M6 mounting screw holes.
- The wire channel (spindle hole) through the safe door must be at least .312 inch (7,9 mm) in diameter.
- The holes should clear of sharp edges or burrs which could damage the lock cable.

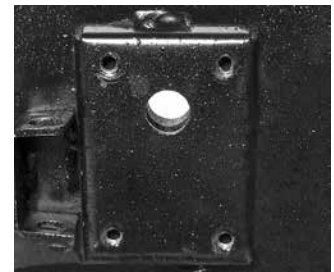
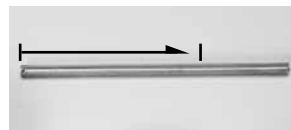

Step 3: Cut Spindle to Proper Length

Measure safe door thickness. This is the dimension between the keypad mounting surface and the lock mounting surface.

Add 13/16" to the door thickness and mark the length on the spindle and cut.

Step 4: Plug the Cable into the Lock

- It is necessary to plug the provided cable into the lock. This is a connector that will only insert one way. Make sure it is fully inserted and locked into the lock case receptacle.

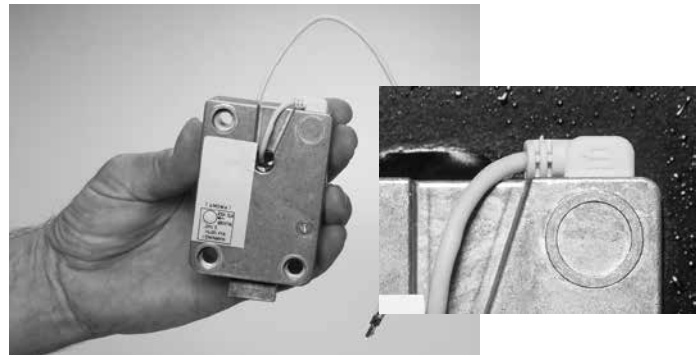

Step 5: Route Cable through lock and spindle

The cable runs in the recess on the lock case and through the spindle hole in the lock.

- Press the cable into the channel that runs through the center of the spindle and slide the spindle toward the lock until it is fully seated in the splines of the lock.



Step 6: Mount the Lock

- Insert the lock cable through the spindle hole and gently pull it from the front of the safe as you place the lock body against the mounting surface.
- After making sure the cable is protected within the lock's recessed channel, and not crimped or stressed at any point, attach the lock body to the mounting surface, using the screws provided.
- Tighten the mounting screws to 30 to 40 inch pounds (33.9 to 45.2dNn)
- Make sure there is a minimum clearance of 0.150 inch (3.8mm) between the end of the lock case and the blocking bar of the safe's boltwork.

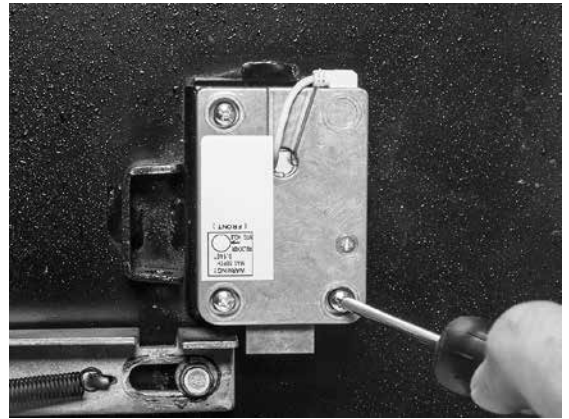

Step 7: Relocking Option

If the safe incorporates a relock device plate, it will likely attach to the lock body as shown at right. If it attaches using the lock's covers screw, make sure the screws engage the lock by at least 4 threads. Substitute longer 8-32 machine screws if necessary. It may be necessary to trim longer screws to a proper working length. Relock device attaching screws must NOT be longer than the depth of the tapped hole provided in the lock case.



Step 8: Check Lock Function

- The lock cannot function properly if it binds against the safe's boltwork. The photo on the left shows boltwork in the fully locked position and placing pressure on the side of the lock bolt. It could prevent the lock from opening. (INCORRECT)
- In the photo on the far right, the boltwork bind has been relieved by removing a small amount of material from the right side of the blocking bar's bolt opening. When the boltwork is fully thrown to the locked position, there is clearance on all sides of the lock's bolt. This is the desired relationship. (CORRECT)

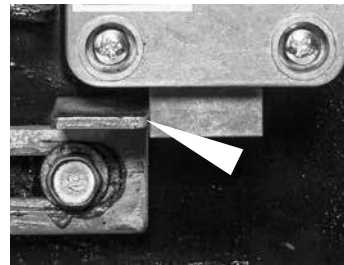

INCORRECT

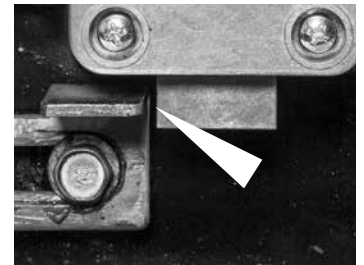

CORRECT

Step 9: Remove Direct Drive Plate Locking Screw

On the rear surface of the keypad you may find a screw installed through the drive plate that prevents it from rotating. This screw must be removed and discarded for this Direct Drive lock to function.



Step 10: Attach Mounting Base

- From the outside of the safe door, bring the lock cable through the center hole in the mounting base.
- Pulling gently on the cable, move the keypad base against the safe door, and attach it using the two screws provided.
- Fasten the base to the safe door using either the silver colored 8-32 machine (silver color) screws or the tinted pair of M4 screws (tinted) whichever is appropriate for the prepared holes in the safe door.
- Do not tighten beyond 15 inch-pounds (1,695 Nm).



Step 11: Plug Cable Into the Keypad

- Plug the lock cable into connector on the PCB
- Ensure the arrow on the plug is facing up.

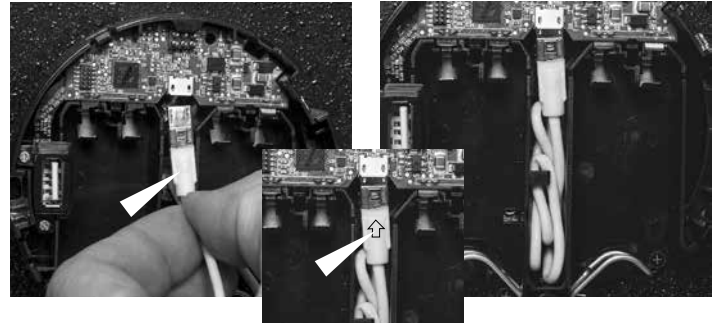

Step 12: Tuck Cable into Recessed Channel

- Place the lock cable into the recessed area.
- The excess cable should be folded and placed into the channel shown at right. Ensure that no part of the cable extends above the wall of the channel, since that will interfere with the keypad placement.

Step 13: Place Keypad onto Base

- Keeping the lock cable in its compartment, place the keypad onto the base. The top seats into the base first, then the bottom.
- Carefully lower the top of the keypad so that the light green area slides between the gold pins and the black plastic tab. Take care not to bend the six gold pins. DO NOT use excessive force to insert the keypad.



Step 14: Batteries

- Open clips as shown at right and prepare to insert batteries. Once batteries are inserted, push clip closed. The battery clip will not latch if battery is inserted backward.
- NOTE the "+" on the 9V battery (small contact) and position it to match the "+" on the Keypad base.



Step 15: Verify Lock Function

- To open the lock, use the factory setting for PIN position 10, with PIN Code 101010. Enter: 10 101010 # and the lock will open. (If lock does not open compare beep patterns heard after pressing the # key, with reference Section 2.3 "Beep Patterns" to identify problem condition.

Step 16: Install One Way Screw

- Install and tighten the keypad security screw as shown.

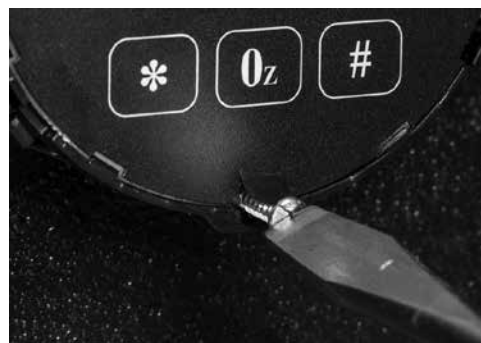

Step 17: Place Chrome Ring Over Base

- Align Chrome Ring as shown and press down over the base.
- For future access to batteries, Chrome Ring can be lifted to expose batteries.



STEP 18: Program Lock

- (See Operating Instructions)



IMPORTANT: Test the lock function at least three times with the door open before closing the safe door with **S&G 3007 Direct Drive USB Audit Lock**

3007 Direct Drive Specifications

Attaching Screws: Use only the screws provided with the lock. They must engage the mounting plate by at least four full threads. Do not use lock washers or thread sealing compounds.

Recommended Attaching Screw Torque: 30 to 40 inch-pounds (33,9 to 45,2 Nm) for the lock body. No more than 15 inch-pounds (1,695 Nm) for the keypad base attaching screws.

Minimum Lock Cable (Spindle) Hole Diameter: 0.375 inch (9,5 mm)

Maximum Lock Cable (Spindle) Hole Diameter: 0.406 inch (10,3 mm)

Lock is Designed to Move: 2.5 lbs. (11,12 Newtons) continuous / 10 lbs. (44,48 Newtons) maximum

Lock Bolt Maximum Free Movement: 0.352 inch (8,95 mm) 0.109 inch (2,77 mm) remains outside the edge of the lock case when bolt is fully retracted.

Maximum Bolt End Pressure: lock designed to withstand at least 225 lbs. (1000 Newtons)

Maximum Bolt Side Pressure: safe and container boltwork or locking cam designs must never apply more than 225 lbs. (1000 Newtons) of side pressure on the lock bolt.

Mounting Environment: The lock body is designed to be mounted inside a secure container. The container must be constructed to offer protection against physical attack directed at the lock. The amount of protection is dependent on the desired level of security for the system as a whole. Lock protection may include barrier materials, relock devices, thermal barriers, thermal relock components, or any combination of these. Relock device attaching screws must NOT be longer than the depth of the tapped hole provided in the lock case. **Security relevant parts of a high security lock should not be accessible to unauthorized persons when the door of the secure storage unit to which it is fitted is open**

A minimum distance of .150 inch (3,8 mm) is recommended between the end of the lock case and the closest approach of the safe's blocking bar or cam plate (which is normally blocked by the extended lock bolt). Maintaining this clearance will allow the lock to deliver optimum performance.

Code Restrictions: Personal data that can be related to a code holder, such as a birth date, street number, or phone number, should not be used in creating a lock code. Avoid codes that can be easily guessed.

Note: Every installation of this product must comply with these requirements and those in the product installation instructions to qualify for the manufacturer's warranty and to comply with EN1300 requirements.

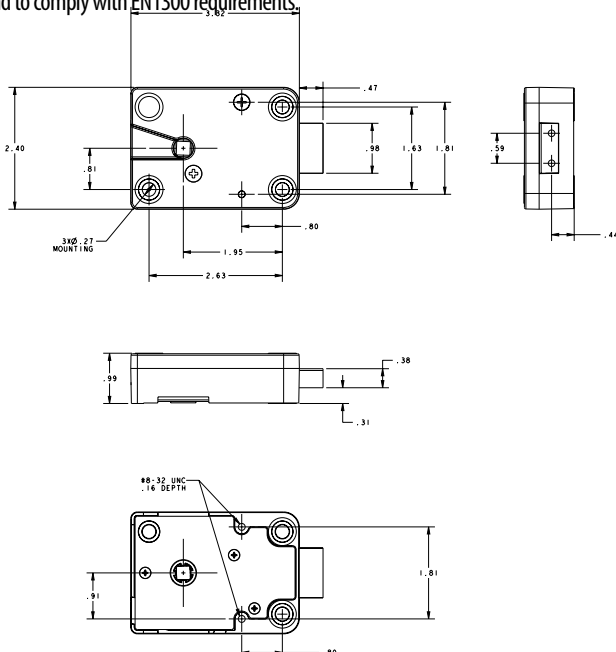

Confidential

The information contained in this document is proprietary to Sargent & Greenleaf, Inc. Publication or duplication of this copyrighted document is strictly prohibited.

S&G Audit Lock Electronic Safe Lock
Limited Warranty

Sargent & Greenleaf, Inc.

A Wholly Owned Subsidiary of Stanley Security Solutions, Inc.

PO Box 930

Nicholasville, KY 40356

Phone: (800)-826-7652 Fax: (800)-634-4843

Phone: (859)-885-9411 Fax: (859)-887-2057

Sargent & Greenleaf S.A.

9, Chemin du Crosset

1024 Ecublens, Switzerland

Phone: +41-21 694 34 00

Fax: +41-21 694 34 09